

**Dustpan & broom**

H.970 W.260 D.232mm  
 Dust pan H.790 W.260 D.232mm  
 Broom H.930 W.220 D.45mm  
 ¥3,600+税

材質：馬毛、PBT  
 プナ材(クリアマットラッカー仕上げ)  
 スチール



**Silver**  
 Model H20-0183SV  
 4 997337 067522



**Olive drab**  
 Model H20-0183OV  
 4 997337 067546



**Gray**  
 Model H20-0183GY  
 4 997337 067553



**Deck brush**

H.1165 W.153 D.43mm  
 ¥1,300+税

材質：PET、プナ材(マットラッカー仕上げ)



**Yellow**  
 Model H20-0184YL  
 4 997337 067560



**Olive drab**  
 Model H20-0184OV  
 4 997337 067577



**Gray**  
 Model H20-0184GY  
 4 997337 067584



**Galvanized bucket**

材質：ガルバナイズドスチール



**1L**  
 Model H19-0047-1  
 H.130 W.155 D.140mm  
 ¥1,400+税  
 4 997337 059183



**4L**  
 Model H19-0047-4  
 H.190 W.235 D.215mm  
 ¥2,100+税  
 4 997337 059176



**6L**  
 Model H19-0047-6  
 H.235 W.265 D.250mm  
 ¥2,300+税  
 4 997337 059169



**12L**  
 Model H19-0047-12  
 H.310 W.310 D.305mm  
 ¥3,000+税  
 4 997337 059145



KITCHENWARE

SMALL SUNDRIES



ORGANIZING &  
CLEANING SUPPLIES  
COLLECTION



**S/2 Cellulose cloth**

H.195 W.170mm  
¥620+税  
材質：セルロース、綿



◎2枚1セット

Back



**Gray**

Model RN-0503GY 4 997337 085380



**Purple**

Model RN-0503PL 4 997337 085373

**Orange**

Model RN-0503OR 4 997337 085397



**Cellulose cloth L**

H.250 W.300mm  
¥700+税  
材質：セルロース、綿

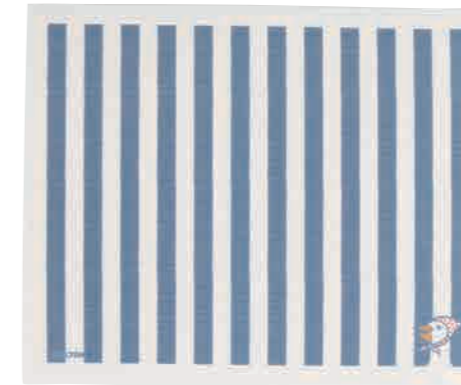

Back

**White**

Model RN-0540L/WT 4 997337 086806



**Orange**

Model RN-0540L/OR 4 997337 086820

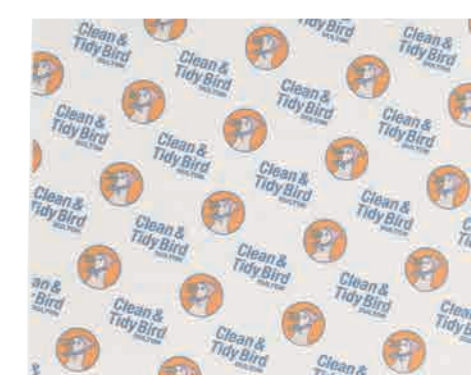

**Yellow**

Model RN-0540L/YL 4 997337 086813

NEW ARRIVAL

CAR & OUTDOOR

FURNITURE

HOUSEWARE

GARDEN & GREEN

KITCHENWARE

SMALL SUNDRIES

**Urethane kitchen sponge S/6**

材質：ポリウレタン

Model RN-0431  
H.29 W.112 D.72mm / pc  
6pcs / set  
¥580+税

4 997337 081337



◎ロットによりスポンジの濃淡に個体差があります。 Package

**3 Layers sponge S/6**

材質：ポリウレタン、ポリエステル、ナイロン

Model RN-0430  
H.35 W.127 D.67mm / pc  
6pcs / set  
¥780+税

4 997337 081320

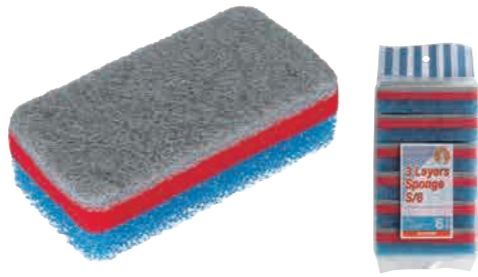

◎ロットによりスポンジの濃淡に個体差があります。 Package



**Stainless steel clothespins**

材質：201ステンレススチール、アルミニウム、スチール



S/5

Model RN-0425-5  
H.83 W.25 D.46mm  
5pcs / set  
¥450+税

4 997337 081184



Package



**Laundry wash bag**

材質：ポリエステル、ポリプロピレン、ポリアセタール



Gusset / S

Model RN-0639S/WT  
H.170 W.250 D.80mm  
¥490+税

4 997337 091152



Gusset / L

Model RN-0639L/WT  
H.200 W.350 D.90mm  
¥590+税

4 997337 091145



Oval / S

Model RN-0640S/WT  
H.200 W.285 D.200mm  
¥440+税

4 997337 091138



Oval / L

Model RN-0640L/WT  
H.250 W.385 D.250mm  
¥540+税

4 997337 091091



**Pinch hanger**

材質：本体 / アルミニウム  
ピンチ、フック / 201ステンレススチール  
ワイヤー / 304ステンレススチール  
リング / ジンクアロイ



S / 12clips

Model RN-0429S/12  
H.17 W.268 D.119mm  
¥980+税

4 997337 081283

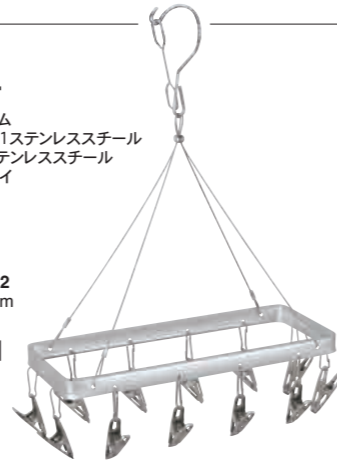

Package

L / 26clips

Model RN-0429L/26  
H.17 W.357 D.270mm  
¥2,100+税

4 997337 081313

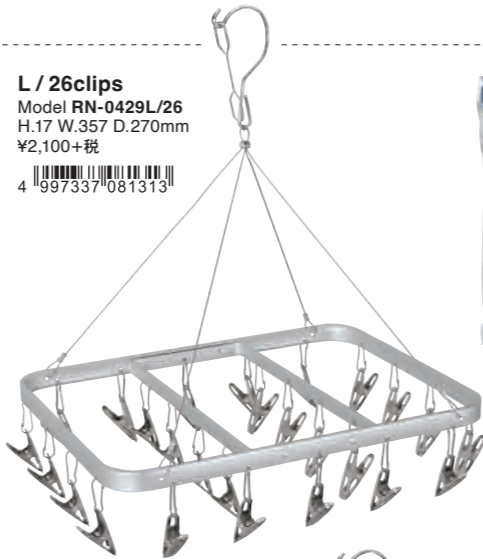

Package

Long / 12clips

Model RN-0429LG/12  
H.17 W.375 D.80mm  
¥980+税

4 997337 081290

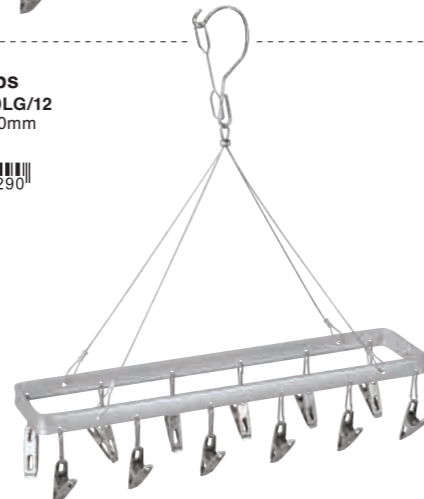

Package



### Mesh pouch

材質：ポリエステル  
ジंकアロイ

◎画像はSサイズ。



<b>S</b>	H.170 W.240mm ¥270+税	<b>Royal blue / S</b> Model RN-0637S/BL 4 997337 090957	<b>Gray / S</b> Model RN-0637S/GY 4 997337 090896	<b>Gray green / S</b> Model RN-0637S/GG 4 997337 090926
<b>M</b>	H.240 W.340mm ¥350+税	<b>Royal blue / M</b> Model RN-0637M/BL 4 997337 090940	<b>Gray / M</b> Model RN-0637M/GY 4 997337 090889	<b>Gray green / M</b> Model RN-0637M/GG 4 997337 090919
<b>L</b>	H.300 W.400mm ¥430+税	<b>Royal blue / L</b> Model RN-0637L/BL 4 997337 090933	<b>Gray / L</b> Model RN-0637L/GY 4 997337 090872	<b>Gray green / L</b> Model RN-0637L/GG 4 997337 090902

### Laundry mesh bag

材質：ポリエステル  
ジंकアロイ

◎画像はSサイズ。

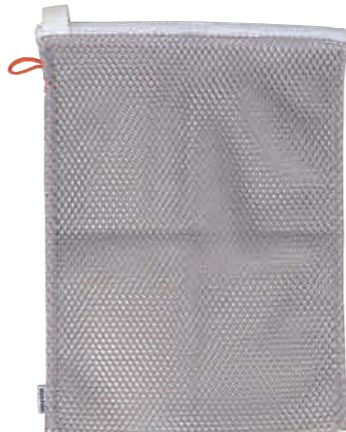

<b>S</b>	H.420 W.300mm ¥400+税	<b>Royal blue / S</b> Model RN-0638S/BL 4 997337 091084	<b>Gray / S</b> Model RN-0638S/GY 4 997337 090971	<b>Gray green / S</b> Model RN-0638S/GG 4 997337 090995
<b>L</b>	H.600 W.420mm ¥700+税	<b>Royal blue / L</b> Model RN-0638L/BL 4 997337 091077	<b>Gray / L</b> Model RN-0638L/GY 4 997337 090964	<b>Gray green / L</b> Model RN-0638L/GG 4 997337 090988



### Squeegee

H.265 W.210mm D.35mm  
¥1,200+税

材質：ワイパー、ストラップ / TPR  
ハンドル / ポリプロピレン



**Red**  
Model RN-0542RD  
4 997337 086882

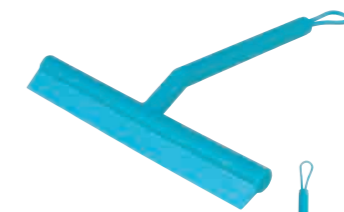

**Blue**  
Model RN-0542BL  
4 997337 086875



**Gray**  
Model RN-0542GY  
4 997337 086868

### Lambswool duster

材質：羊毛、ピーチ材、ポリプロピレン



**Mini**  
Model RN-0428S  
L.300mm  
¥1,200+税  
4 997337 081269

**Long**  
Model RN-0428L  
L.700mm  
¥1,900+税  
4 997337 081276

Package



### Size

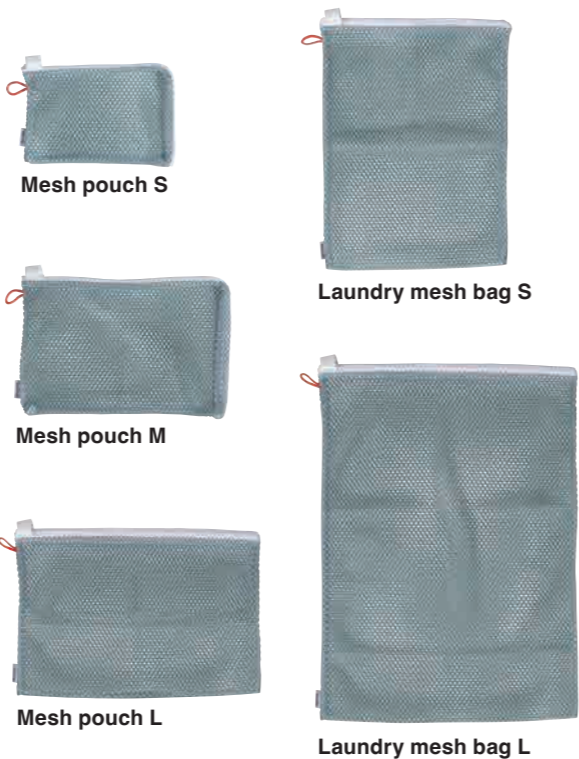

**Feather duster**

材質：オーストリッチフェザー  
竹、合成皮革



**Mini White**

Model H20-0138WT  
L.205mm  
Handle L.95mm  
¥900+税



**Mini Gray**

Model H20-0138GY  
L.205mm  
Handle L.95mm  
¥900+税



**40cm**

Model S455-190-4  
L.400mm  
Handle L.220mm  
¥1,700+税



**60cm**

Model S455-190-6  
L.600mm  
Handle L.420mm  
¥2,000+税



オーストリッチフェザー製品について

- ◎羽根部分は天然の材質を使用している為、水洗いや洗剤等のご使用はお止めください。
- ◎羽根にクセをつけにくくする為、長期間ご使用にならない時は、吊るす等して羽根に負荷を掛けない様に保管してください。
- ◎使用後はホコリをふるい落とし、風通しの良い場所に保管してください。



**Microfiber towels**

H.150 W.205 D.205mm  
Cloth size 400×400mm  
12 sheets

¥2,500+税

材質：ポリエステル85%、  
ポリアミド15%

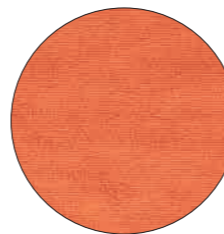

**Orange**

Model X24-0765OR

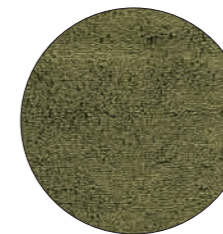

**Olive**

Model X24-0765OV



**Spray bottle pro 1000**

H.325 W.105 D.87mm 1000ml

¥600+税

材質：本体 / HDPE

スプレー / ポリプロピレン、ステンレススチール

LOT 2pcs

- ◎ノズルを回すことにより  
ストレートorミストの調整可能。



**Blue**

Model RNR-0470BL



**Red**

Model RNR-0470RD



Back

**Microfiber table wipes**

H.60 W.200mm D.80mm

Cloth size 200×200mm

12 sheets

¥500+税

材質：ポリエステル85%

ポリアミド15%

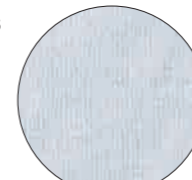

White

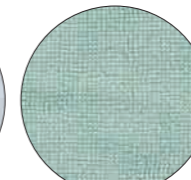

Mint green



**White**

Model XR23-0530WT



**Mint green**

Model XR23-0530MGN





### Tissue case

280×170mm  
¥1,200+税  
材質：本体/コットン43%、ポリエステル42%、  
ビスコース15%  
リボン/ポリエステル100%

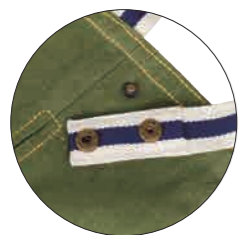

◎ストラップボタンは  
2段階で長さ調整が可能です。



Back

**Stripe mint green**  
Model RN-0746TC/GN

4 997337 094887

**Stripe light gray**  
Model RN-0746TC/GY

4 997337 094894

**Stripe navy blue**  
Model RN-0746TC/NB

4 997337 094870

◎ソフトバックのティッシュペーパー用です。  
◎ティッシュペーパーは付属しません。

◎ハンドメイドのため、染色の際に生地が縮み、多少サイズに個体差があります。色ムラ・糸のほつれ・糸飛び等があります。製品の特性としてご理解ください。  
◎ニオイが気になる場合は、風通しの良い場所で陰干しすることにより解消されます。洗濯の際は他の物と分けて洗ってください。◎濃色は色移りする恐れがあります。必ず他の物と分けて洗ってください。

### Foldable tissue box

H.77 W.260 D.140mm  
Inside H.65 W.250 D.125mm  
¥3,200+税

◎形状によっては収納できません。



Folding

**Beige**  
Model H20-0155BE

材質：ポリウレタン  
マイクロファイバー

4 997337 066679

**Dark cork**  
Model H20-0155DCK

材質：コルクシート、ポリウレタン  
マイクロファイバー

4 997337 066723

**Dark brown**  
Model H20-0155DBR

材質：ポリウレタン  
マイクロファイバー

4 997337 066686

**Light denim**  
Model H20-0155LDM

材質：コットン、ポリウレタン  
マイクロファイバー

4 997337 066709

**Navy**  
Model H20-0155NB

材質：ポリウレタン  
マイクロファイバー

4 997337 066693



### S/3 Waffle indie hand towel

320×320mm  
¥1,650+税  
材質：コットン100%  
◎3枚1セット

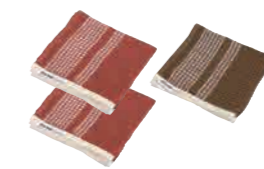

**Red & Brown**  
Model RNZ-0471RD/BR

4 997337 083997

Red×2pcs



Brown×1pc

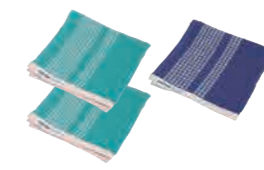

**Gray green & Blue**  
Model RNZ-0471GG/BL

4 997337 084000

Gray green×2pcs



Blue×1pc



### Waffle indie towel

1200×500mm  
¥2,000+税  
材質：コットン100%



**Red**  
Model RNZ-0472RD

4 997337 084017

**Brown**  
Model RNZ-0472BR

4 997337 084024

**Gray green**  
Model RNZ-0472GG

4 997337 084031

**Blue**  
Model RNZ-0472BL

4 997337 084048

◎こちらのページの製品はハンドメイドのため、サイズや色の濃淡・材質の風合いに多少の個体差があります。製品の特性としてご理解ください。  
◎洗濯は必ず手洗いで他の物と分けて洗ってください。



### Towel holder square

55×55 D.23mm  
材質：18-0ステンレススチール、TPR  
強力両面テープ付属



**Ivory**  
Model CH04-H116IV  
¥800+税  
4 997337 078535

**Satin finish**  
Model CH04-H116  
¥800+税  
4 997337 411608

### Towel holder round

φ55 D.23mm  
材質：18-0ステンレススチール、TPR  
強力両面テープ付属



**Ivory**  
Model CH04-H117IV  
¥800+税  
4 997337 078542

**Mirror finish**  
Model CH04-H117  
¥800+税  
4 997337 411707

◎ざらつき及び凸凹がある場所には取り付けできません。

### 4-holes toothbrush holder

H.120 φ70mm



**Ivory**  
Model CH03-H92IV  
¥1,500+税  
材質：Top / 18-0ステンレススチール  
Bottom / 439ステンレススチール  
4 997337 078658

**Satin finish**  
Model CH03-H92ST  
¥1,400+税  
材質：304ステンレススチール  
4 997337 723008

**Mirror finished**  
Model CH03-H92MF  
¥1,500+税  
材質：304ステンレススチール  
4 997337 723015

### Tube squeezer with stand

Model H21-0366  
H.40 W.86 D.30mm  
¥1,500+税  
材質：304ステンレススチール  
4 997337 078757



**Dental floss**  
Model S175-34  
Case H.38 W.26 D.15mm  
(チェーン除く)  
15m /roll  
¥250+税  
材質：ナイロン(フロス)  
LOT 15pcs  
4 997337 175340

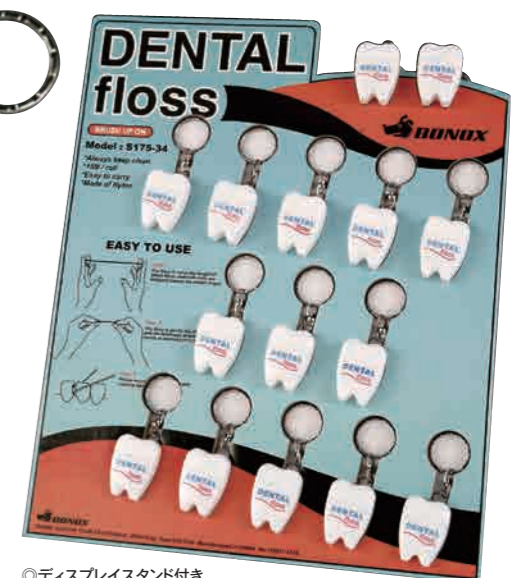

◎ディスプレイスタンド付き



**Magnetic soap holder**  
Model CH12-H463  
W.50 D.65mm  
¥900+税

4 997337 124638



◎ホルダー部分に固形石けんをセットして使用します。  
◎ざらつき及び、凹凸のある設置面には取り付けできません。  
◎石けんは付属しません。



**Stainless steel soap dispenser**  
Model K755-921  
H.110 φ115mm 450ml  
¥2,400+税  
液体タイプ専用

材質：本体/18-8ステンレススチール  
ポンプ/ポリエチレン

4 997337 759212



**Stainless steel soap dispenser**  
Model K755-917  
H.120 W.105 D.100mm 500ml  
¥2,400+税  
液体タイプ専用

材質：本体/18-8ステンレススチール  
ポンプ/ポリエチレン

4 997337 759175



**Stainless steel tumbler**  
Model K555-348  
H.95 φ75mm 400ml  
¥1,000+税

4 997337 553483



**Dust bin "Tambor" 1L  
Satin finished**  
Model K555-527ST  
H.140 φ120mm  
¥3,200+税

4 997337 527194

**Enameled tumbler**  
Model H19-0093  
H.95 φ90mm 290ml  
¥800+税  
材質：エナメル、スチール

LOT 4pcs

4 997337 062862



**Enameled utensil pot**  
Model H19-0097  
H.123 φ123mm  
¥1,000+税  
材質：エナメル、スチール

4 997337 062923



**Enameled soap dish**  
Model CH13-H490  
H.25 W.155 D.105mm  
¥1,200+税  
材質：エナメル、スチール

4 997337 134903



**Enameled washbowl**  
材質：エナメル、スチール

**S**  
Model H19-0096S  
H.113 φ229mm  
¥1,300+税

4 997337 062909



**M**  
Model H19-0096M  
H.130 φ276mm  
¥1,700+税

4 997337 062916



**Rectangle mirror with tray**  
Model K755-920 H.245 W.120 D.120mm  
¥2,200+税 Mirror 150×105mm

4 997337 920759



**Rectangle mirror with tray W18**  
Model K855-1098 H.238 W.200 D.133mm  
¥2,600+税 Mirror 135×180mm

4 997337 810982



**Rectangle stand mirror**  
Model G755-906 H.310 W.165 D.125mm  
¥3,500+税 Mirror 230×165mm

4 997337 759069



**Round stand mirror**  
Model G755-903 H.280 W.165 D.120mm  
¥2,400+税 Mirror φ150mm  
両面鏡：片面3倍鏡

4 997337 759038



**Swing stand mirror**  
Model G755-904 Base size 100×160mm  
¥2,800+税 Base arm L.140mm  
Mirror φ170mm  
両面鏡：片面3倍鏡

4 997337 759045



**Extending mirror**  
Model G755-907 H.375  
¥3,000+税 Arm L.90~490mm  
Mirror φ173mm  
両面鏡：片面3倍鏡  
取付ネジ付属

4 997337 759076







**Tissue dispenser**  
Model 100-160N  
H.145 W.260 D.125mm  
Inside H.100 W.240 D.110mm  
Weight 1.2kg

for your convenience

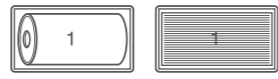

Kitchen paper

Paper towel



Tissue paper box L (~H.100mm)

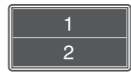

Tissue paper box S (~H.53mm)



Vibration

付属のラバースタンドを使用する事で、置き型のディスペンサーとしても使用できます。

Color	Price	Barcode
Vibration	¥6,900+税	4 997337 068666
Stainless	¥6,800+税	4 997337 860994
Ivory		4 997337 860918
Red		4 997337 860925
Yellow	¥3,600+税	4 997337 860932
Sax		4 997337 860949
H.gray		4 997337 860970
Olive		4 997337 068673



Stainless



**Tissue dispenser**  
材質：304 ステンレススチール

- ◎壁取り付け可能。
- ◎ティッシュペーパーは付属しません。

Model TD08-313  
H.55 W.265 D.140mm  
Inside H.50 W.260 D.122mm  
Weight 0.6kg  
¥6,800+税



**half**  
Model TD08-313S  
H.72 W.145 D.120mm  
Inside H.67 W.140 D.107mm  
Weight 0.35kg  
¥4,800+税



◎H.60 W.125 D.105mm以下のティッシュペーパー用です。(コンパクトタイプ専用)



Black

**Paper holder**

材質：アイアン

**Single**  
H.40 W.140 D.115mm



**Antique brass**  
Model H20-0206ABS  
¥1,600+税



**Black**  
Model H20-0206BK  
¥1,400+税



Antique brass

**Single cover**  
H.65 W.125 D.110mm



**Antique brass**  
Model H20-0207ABS  
¥2,000+税



**Black**  
Model H20-0207BK  
¥1,800+税



◎トイレットペーパーは付属しません。



**Paper holder**

Model 7651N  
W.150mm  
¥2,800+税



**Towel ring**

Model 7660  
W.165 D.90mm  
¥2,400+税



**Single hook**

Model XT-708  
L.50 φ25mm  
¥800+税



◎トイレットペーパーは付属しません。

**Folding hanger**

Model 121-374  
H.200 W.450 D.47mm  
Folding 240×55×47mm  
¥900+税

材質：スチール (粉体塗装)

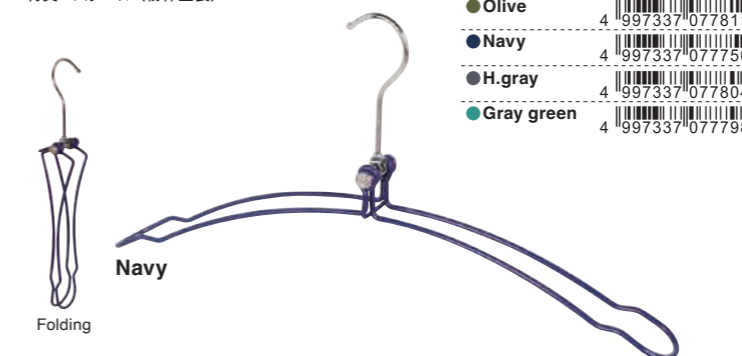

Navy

Folding

Color	Barcode
Ivory	4 997337 077767
Red	4 997337 077774
Yellow	4 997337 077781
Olive	4 997337 077811
Navy	4 997337 077750
H.gray	4 997337 077804
Gray green	4 997337 077798

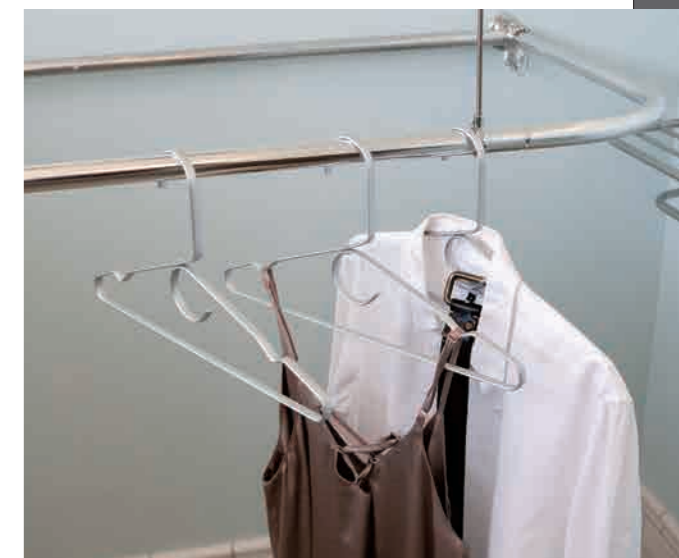

**S/3 Aluminum hanger**

Model RNR-0644S/3  
H.218 W.412 D.10mm  
3pcs / set  
¥1,200+税

材質：アルミニウム



◎3本1セット



**Porcelain hook** 材質：ポーセリン  
取付用ビス2pcs付属



**Single hook**

Model Y-0617/1  
H.61 W.86 D.52mm  
¥800+税



**2 prong hook**

Model Y-0617/2  
H.61 W.159 D.52mm  
¥1,200+税



**3 prong hook**

Model Y-0617/3  
H.61 W.231 D.52mm  
¥1,600+税



**4 prong hook**

Model Y-0617/4  
H.61 W.305 D.52mm  
¥2,000+税



**5 prong hook**

Model Y-0617/5  
H.61 W.379 D.52mm  
¥2,400+税



**Porcelain robe hook** 材質：ポーセリン  
取付用ビス2pcs付属



Model Y-0615  
H.75 W.120 D.75mm  
¥900+税



Model Y-0616  
H.82 W.87 D.93mm  
¥900+税



**Porcelain shelf** 材質：ポーセリン  
取付用ビス2pcs付属



Model Y-0612  
H.70 W.590 D.135mm  
¥3,600+税



**Porcelain soap dish** 材質：ポーセリン  
取付用ビス2pcs付属



Model Y-0611S  
H.65 W.200 D.115mm  
¥1,500+税



**Porcelain big soap dish** 材質：ポーセリン  
取付用ビス2pcs付属



Model Y-0611L  
H.80 W.242 D.135mm  
¥1,800+税



**Porcelain toilet paper holder** 材質：ポーセリン、ポリプロピレン  
取付用ビス2pcs付属



Model Y-0609  
H.77 W.207 D.105mm  
¥1,800+税



Model Y-0610  
H.115 W.177 D.103mm  
¥1,800+税



**Porcelain towel bar** 材質：ポーセリン、201ステンレススチール  
取付用ビス4pcs付属



Model Y-0614  
H.68 W.650 D.95mm  
¥2,000+税



**Porcelain towel ring**

材質：ポーセリン、201ステンレススチール  
取付用ビス 2pcs付属



Model Y-0613  
H.225 W.205 D.76mm  
¥1,600+税



**Aluminum clothes hanger**

材質：アルミニウム



Model CH10-H411  
H.240 W.440 D.50mm  
¥2,400+税



Model CH10-H411N  
H.230 W.440 D.50mm  
¥2,200+税



◎仕上げの際の細かな磨き跡が生じてしまう場合があります。  
製品の特性としてご理解ください。

**Shoehorn**

材質：アルミニウム



**L**  
Model H20-0248L  
L.520 W.40mm  
¥2,200+税

**LOT 2pcs**



**S**

Model H20-0248S  
L.250 W.40mm  
¥1,800+税

**LOT 4pcs**



**Clothes brush**

Model R655-796  
L.225 35×35mm  
¥1,000+税

材質：天然木、牛革  
馬毛100%

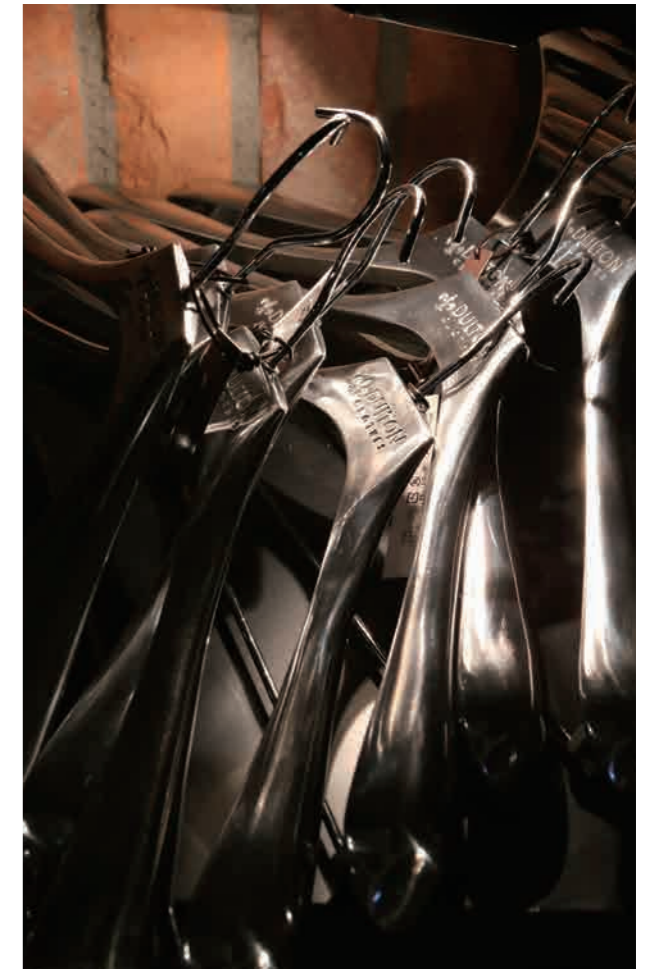



### Aluminum wall rack

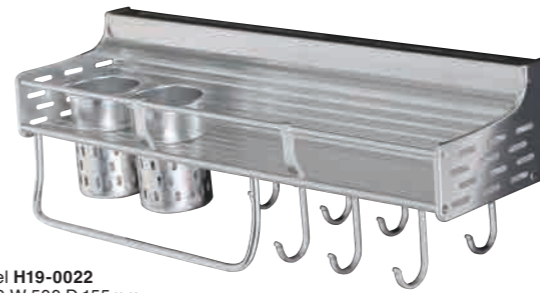

Model H19-0022  
H.190 W.500 D.155mm  
¥6,000+税  
4 997337 007870

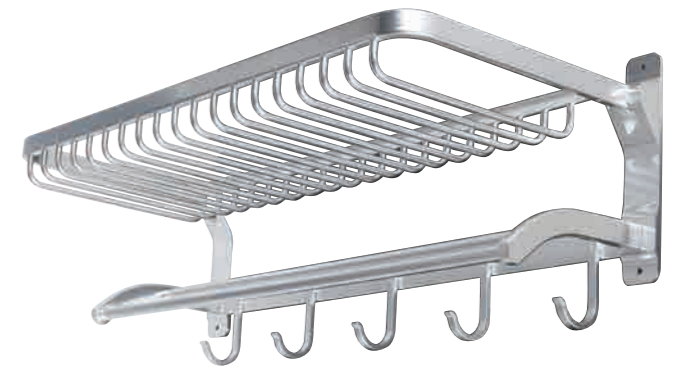

Model H19-0023  
H.220 W.600 D.250mm  
¥8,500+税  
4 997337 007894



### Aluminum wall shelf

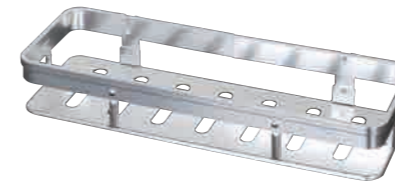

Model H19-0026  
H.67 W.400 D.140mm  
¥2,800+税  
4 997337 007962



### Stainless magnetic tool holder

材質：18-8ステンレススチール  
マグネット  
取付け用ネジ 2pcs 付属



25  
Model G655-750-25  
H.47 W.250 D.15mm  
¥2,600+税  
4 997337 675017



45  
Model G655-750-45  
H.47 W.450 D.15mm  
¥3,600+税  
4 997337 675024



### Aluminum hook

材質：アルミニウム  
取付けビス4pcs 付属

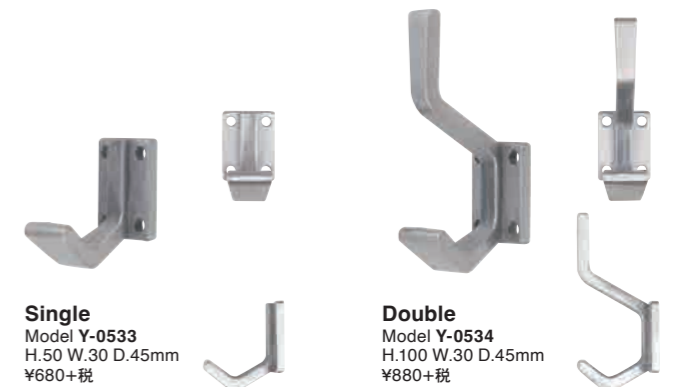

Single  
Model Y-0533  
H.50 W.30 D.45mm  
¥680+税  
4 997337 086547

Double  
Model Y-0534  
H.100 W.30 D.45mm  
¥880+税  
4 997337 086554



**Aluminum bar handle**

材質：アルミニウム  
取付ビス付属



**S**  
Model **D21-0330S**  
H.300 W.35 D.65mm  
¥3,500+税  
4 997337 076838

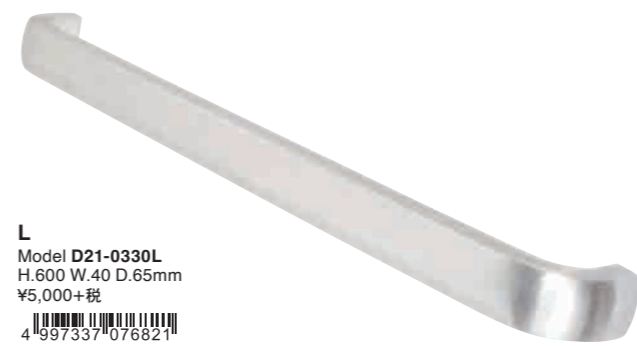

**L**  
Model **D21-0330L**  
H.600 W.40 D.65mm  
¥5,000+税  
4 997337 076821



**Aluminum door handle**

材質：アルミニウム  
取付ビス用付属



**Push**  
Model **D21-0329**  
H.120 W.90 D.60mm  
¥6,000+税  
4 997337 076814



**Pull**  
Model **Y-0532**  
H.120 W.90 D.60mm  
¥6,000+税  
4 997337 086530



Model **D21-0328**  
H.60 W.136 D.50mm  
¥1,800+税  
4 997337 076807



Model **D21-0331**  
H.60 W.110 D.42mm  
¥2,000+税  
4 997337 076845

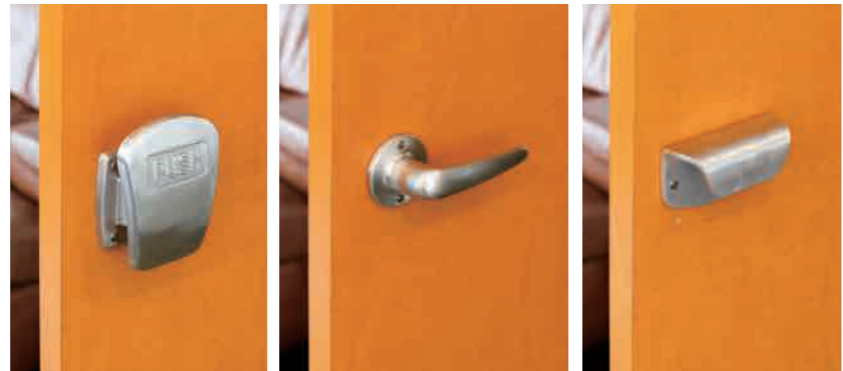

**Aluminum bracket**

材質：アルミニウム  
取付用ビス3pcs 付属

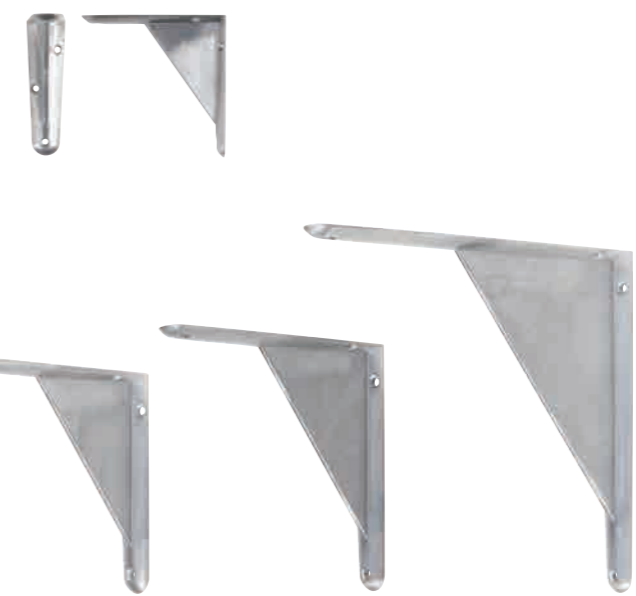

**Bracket "10"**  
Model **Y-0535-10**  
H.100 W.30 D.100mm  
¥1,000+税  
4 997337 086561

**Bracket "12"**  
Model **Y-0535-12**  
H.125 W.30 D.125mm  
¥1,200+税  
4 997337 086578

**Bracket "14"**  
Model **Y-0535-14**  
H.140 W.30 D.140mm  
¥1,400+税  
4 997337 086585

**Bracket "19"**  
Model **Y-0535-19**  
H.195 W.35 D.195mm  
¥1,800+税  
4 997337 086592



© 棚板用のビスは付属しません。棚板の材質や厚さに合った市販のビスをお買い求めください。

**Bar**

材質：アイアン  
取付ビス付属

**Bar 25**  
H.70 W.250 D.60mm  
¥900+税

**Black**  
Model D20-0122-2BK  
4 997337 064378



**Gold**  
Model D20-0122-2GD  
4 997337 064385



**Triangle hook**

H.160 W.160 D.50mm  
¥950+税  
材質：アイアン  
取付ビス付属

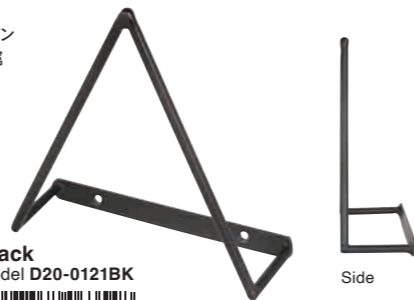

**Black**  
Model D20-0121BK  
4 997337 063548

**Bar 50**  
H.70 W.500 D.60mm  
¥1,000+税

**Black**  
Model D20-0122-5BK  
4 997337 063555



**Gold**  
Model D20-0122-5GD  
4 997337 063562



**Bar 60**  
H.70 W.600 D.60mm  
¥1,100+税

**Black**  
Model D20-0122-6BK  
4 997337 063579



**Gold**  
Model D20-0122-6GD  
4 997337 063586



**Bar 70**  
H.70 W.700 D.60mm  
¥1,150+税

**Black**  
Model D20-0122-7BK  
4 997337 063593



**Gold**  
Model D20-0122-7GD  
4 997337 063609



**Belt bracket**



**Belt bracket**  
Model Y955-1249  
H.168 W.40 D.230mm  
¥1,650+税

木板サイズ：H.25 D.200mm 以内  
1×8材 (19×184mm) が収まります。

4 997337 924917

**Belt bracket with ring**  
Model Y955-1249R  
H.168 W.40 D.230mm  
¥1,850+税

木板サイズ：H.25 D.200mm 以内  
1×8材 (19×184mm) が収まります。

リングに入る丸棒サイズ：φ25mm 以内

4 997337 924924

**Adjustable bracket**



**S**  
Model K655-699S  
H.90 W.120 D.35mm  
¥850+税  
4 997337 669917

**L**  
Model K655-699L  
H.140 W.180 D.55mm  
¥1,650+税  
4 997337 669931

**Hanging bracket**  
Model R855-1009  
H.175 W.32 D.160mm  
¥1,250+税  
4 997337 810098



**Bracket 12**  
Model S555-376-12  
H.120 W.120 D.26mm  
¥650+税  
4 997337 376129

**Bracket**  
Model S555-376  
H.185 W.185 D.30mm  
¥900+税  
4 997337 553766

**Bracket**  
Model S555-375  
H.210 W.210 D.25mm  
¥1,250+税  
4 997337 553759

**Bracket**



**Bracket 10**  
Model S355-85-10ABK  
H.100 W.100mm  
¥650+税  
4 997337 859103

**Bracket 14**  
Model S355-85-14ABK  
H.140 W.140mm  
¥850+税  
4 997337 859141

**Bracket 18**  
Model S355-85-18ABK  
H.180 W.180mm  
¥1,050+税  
4 997337 859189

**Bracket 23**  
Model S355-85-23ABK  
H.230 W.230mm  
¥1,450+税  
4 997337 859233

**Bracket 27**  
Model S355-85-27ABK  
H.270 W.270mm  
¥1,850+税  
4 997337 859271

**Bow bracket**



**Bow bracket "10"**  
Model S555-353-10  
H.100 W.100mm  
¥500+税  
4 997337 353106

**Bow bracket "14"**  
Model S555-353-14  
H.140 W.140mm  
¥750+税  
4 997337 353144

**Bow bracket "19"**  
Model S555-353-19  
H.195 W.195mm  
¥1,050+税  
4 997337 353199

**Bow bracket "25"**  
Model S555-353-25  
H.250 W.250mm  
¥2,250+税  
4 997337 353250

◎こちらのページに掲載されている製品は、アンティークの雰囲気を出す為の仕上げ(色ムラ・塗装はがれ等)が施されています。  
◎塗装の風合いに多少の個体差があります。◎設置面に「サビ」が色移りする場合があります。製品の特性としてご理解ください。 材質：アイアン 取付ビス付属



**Small double hook**  
Model S255-101ABK  
H.80 W.32 D.48mm  
¥400+税  
4 997337 510196



**Small single hook**  
Model S255-100ABK  
H.33 W.24 D.33mm  
¥350+税  
4 997337 510097



**Wall hook**  
Model S255-92ABK  
H.75 W.35 D.85mm  
¥450+税  
4 997337 559218



**Iron hook S**  
Model S255-91S/ABK  
H.120 W.35 D.45mm  
¥650+税  
4 997337 959117



**Ceiling s-hook**  
Model K655-702  
H.78 W.48 D.98mm  
¥650+税  
4 997337 657020



**Ceiling hook 60**  
Model S355-89ABK  
H.75 W.60 D.48mm  
¥450+税  
4 997337 955898



**Ceiling hook**  
Model S255-99ABK  
H.100 W.105 D.70mm  
¥750+税  
4 997337 559911



**Ceiling Ring S**  
Model R855-1008S  
H.80 W.80 D.33mm  
リング内径φ10mm  
¥750+税  
4 997337 810814



**2 swing wall hook**  
Model S255-89ABK  
H.57 W.42 D.125mm  
¥750+税  
4 997337 558914



**Double swing wall hook**  
Model S255-88ABK  
H.83 W.40 D.70mm  
¥550+税  
4 997337 558815



**Wave hook**  
Model S355-107ABK  
H.190 W.40 D.175mm  
¥700+税  
4 997337 107990



**Cloth rack hook**  
Model S355-108ABK  
H.160 W.40 D.175mm  
¥550+税  
4 997337 108997



**Bull skull hook**  
Model S555-379  
H.145 W.140 D.65mm  
¥950+税

Color  
● Classic ivory  
● Antique black



**Lizard hook**  
Model S255-90ABK  
H.180 W.86 D.50mm  
¥900+税  
4 997337 559010



**Cats hook**  
Model HL4360-6ABK  
H.90 W.200mm  
¥1,300+税  
4 997337 943604



**2 branch hook S**  
Model S355-91S/ABR  
H.200 W.100 D.60mm  
¥900+税  
4 997337 591812



**2 branch hook**  
Model S355-92ABR  
H.90 W.135 D.58mm  
¥650+税  
4 997337 559287



**Left direction**  
Model S355-93ABK  
H.56 W.128 D.15mm  
¥450+税  
4 997337 593090



**Right direction**  
Model S355-94ABK  
H.56 W.128 D.15mm  
¥450+税  
4 997337 594097

◎こちらのページに掲載されている製品は、アンティークの雰囲気を出す為の仕上げ(色ムラ・塗装はがれ等)が施されています。  
◎塗装の風合いに多少の個体差があります。  
◎設置面に「サビ」が色移りする場合があります。製品の特性としてご理解ください。  
材質: アイアン 取付ビス付属

**Handle**  
Model K555-499  
材質: アイアン



**L**  
H.350 W.35 D.75mm  
¥1,750+税  
4 997337 549936

**Door Handle**  
Model K555-502  
材質: アイアン



**S**  
H.240 W.42 D.55mm  
¥950+税  
4 997337 550215



**L**  
H.310 W.45 D.60mm  
¥1,350+税  
4 997337 550236

**Metal chalkboard**  
材質: スチール



**13**  
Model K955-1264-13  
H.135 W.210 D.75mm  
¥1,600+税  
4 997337 212649



**27**  
Model K955-1264-27  
H.270 W.210 D.140mm  
¥2,700+税  
4 997337 112642



**Hanging sign**  
材質: アイアン  
取付ビス付属



**28**  
Model R655-747-28  
H.190 W.280 D.30mm  
Board H.110 W.240mm  
¥2,100+税  
4 997337 747288



**35**  
Model R655-747-35  
H.225 W.345 D.40mm  
Board H.140 W.300mm  
¥2,900+税  
4 997337 747356

◎こちらのページに掲載されている製品は、アンティークの雰囲気を出す為の仕上げ(色ムラ・塗装はがれ等)が施されています。  
◎塗装の風合いに多少の個体差があります。◎設置面に「サビ」が色移りする場合があります。製品の特性としてご理解ください。



**Reversible sign**

材質：アイアン



**Reversible sign stand "OPEN-CLOSED"**

Model S455-180C  
H.95 W.165 D.72mm  
¥1,500+税



◎両面が利用可能です。



**Reversible sign stand "RESERVED"**

Model S455-175RE  
H.85 W.155 D.72mm  
¥1,300+税



◎両面が利用可能です。  
◎両面とも「RESERVED」表示です。



**Reversible sign stand "CASHIER"**

Model R655-744  
H.80 W.160 D.65mm  
¥1,300+税



◎両面が利用可能です。  
◎両面とも「CASHIER」表示です。



**Reversible sign "OPEN-CLOSED"**

Model S455-1740C  
H.95 W.165mm  
¥1,600+税



◎両面が利用可能です。

**Iron sign**

材質：アイアン  
取付ビス付属

**"TOILET"**

Model 405  
H.50 W.175mm  
¥1,100+税



**"STAFF ONLY"**

Model 2430  
H.50 W.225mm  
¥1,400+税



**Iron sign "BICYCLE PARKING"**

材質：アイアン  
取付ビス付属

Model R855-994  
H.145 W.195 D.5mm  
¥1,500+税



Black



Blue



**Iron sign "NO PARKING"**

Model R655-745  
H.120 W.190 D.5mm  
¥1,200+税



◎こちらのページに掲載されているアイアン製品は、アンティークの雰囲気を出す為の仕上げ(色ムラ・塗装はがれ等)が施されています。  
◎塗装の風合いに多少の個体差があります。  
◎設置面に「サビ」が色移りする場合があります。製品の特性としてご理解ください。



**Fiber sign A**

材質：ポリウレタン、グラスファイバー

**Gents**

Model AS-0785GE  
H.43 W.138 D.3mm  
¥1,700+税



**Ladies**

Model AS-0785LA  
H.43 W.138 D.3mm  
¥1,700+税



**Private**

Model AS-0785PR  
H.43 W.138 D.3mm  
¥1,700+税



**Toilet**

Model AS-0785TO  
H.43 W.138 D.3mm  
¥1,700+税



**Push**

Model AS-0785PS  
H.43 W.138 D.3mm  
¥1,700+税



**Pull**

Model AS-0785PL  
H.43 W.138 D.3mm  
¥1,700+税



**Staff only**

Model AS-0785ST  
H.41 W.168 D.3mm  
¥1,800+税



◎ビス穴 φ4mm  
◎取付ビスは付属しておりません。  
◎プリントの発色や位置等に個体差があります。  
◎生産工程中に細かなキズや塗装剥げ等が生じる場合があります。製品の特性として、ご理解ください。

**Fiber sign B**

材質：不飽和ポリエステル樹脂  
グラスファイバー

◎ビス穴 φ4mm  
◎取付ビスは付属しておりません。

◎プリントの発色や位置等に個体差があります。  
◎生産工程中に細かなキズや塗装剥げ等が生じる場合があります。製品の特性として、ご理解ください。

**Men**

Model AS-0786MN  
H.40 W.172 D.3mm  
¥1,700+税



**Women**

Model AS-0786WM  
H.40 W.172 D.3mm  
¥1,700+税



**Private**

Model AS-0786PR  
H.40 W.172 D.3mm  
¥1,700+税



**Toilet**

Model AS-0786TO  
H.40 W.172 D.3mm  
¥1,700+税



**Push**

Model AS-0786PS  
H.40 W.172 D.3mm  
¥1,700+税



**Pull**

Model AS-0786PL  
H.40 W.172 D.3mm  
¥1,700+税



**Staff only**

Model AS-0786ST  
H.40 W.220 D.3mm  
¥1,800+税



**Push type-2**

Model AS-0786PS2  
H.172 W.40 D.3mm  
¥1,700+税



**Pull type-2**

Model AS-0786PL2  
H.172 W.40 D.3mm  
¥1,700+税





### Art frame

材質：天然木、ガラス、MDF



**Volkman**  
Model XR22-0433V  
H.400 W.300 D.30mm  
Weight 約1.3kg  
¥4,200+税  
4 997337 082877



**"Medford"**  
Model G855-1047MF  
H.475 W.320 D.34mm  
Weight 約1.5kg  
¥4,000+税  
4 997337 847025



**"My pal"**  
Model G855-1047MP  
H.475 W.320 D.34mm  
Weight 約1.5kg  
¥4,000+税  
4 997337 847032



**Aero**  
Model XR22-0433A  
H.600 W.400 D.30mm  
Weight 約2.5kg  
¥6,000+税  
4 997337 082907

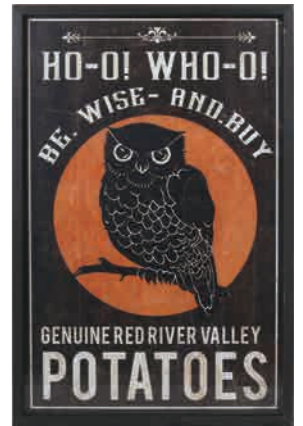

**Black owl**  
Model XR22-0433BO  
H.600 W.400 D.30mm  
Weight 約2.5kg  
¥6,000+税  
4 997337 082921

### Canvas art

材質：天然木、キャンバス、MDF



**Old elm**  
Model XR22-0434OE  
H.600 W.400 D.30mm  
Weight 約1kg  
¥5,800+税  
4 997337 082938



**Indian-A**  
Model XR22-0434A  
H.700 W.400 D.30mm  
Weight 約1.2kg  
¥5,800+税  
4 997337 082945

### Galvanized frame stand

材質：スチール、MDF、アクリル



**A4**  
Model RN-0400-A4  
H.360 W.270 D.20mm  
¥4,500+税  
4 997337 080538



**A3**  
Model RN-0400-A3  
H.500 W.380 D.20mm  
¥8,000+税  
4 997337 080521



**A0**  
Model RN-0400-A0  
H.1245 W.905 D.20mm  
¥36,000+税  
4 997337 080507